

## Clear Cone Monitor

The optional Clear Cone provides all round high visibility position monitoring on all limit switch boxes and positioner models. A red/green colour coded monitor is sealed inside a robust, clear polycarbonate cover. Positioner models are marked with black printed legible angle scales.

The monitor is also available directly mounted onto actuator models 03, 05, 07, 08, 09 and 10, all EHD units and 12, 14 & 15 using an adaptor plate.

For highly corrosive environments special cover materials are available - contact Kinetrol for details.

Conductive ATEX approved versions (to Category 1) are also available - contact Kinetrol for details.

For dimensions see pages 61, 62, 63 & 64.



## Solenoid Valves

As an option Kinetrol actuator sizes 03 to 15 can be supplied with integral solenoid valves with NAMUR interface. Air is ported through the actuator body via an adaptor so no external tubing is necessary.

Standard optional solenoid valves can be converted to 5 or 3 port versions by changing the valve body plate supplied with the valve.



### Specification

<b>Coil Voltages</b>	AC: 50/60Hz 110V ac, 240V ac and 24V dc For other voltages contact Kinetrol
<b>Electrical Connection</b>	DIN 43650 plug with Pg9 cable gland (6-8mm dia) as standard
<b>Manual Override</b>	extra to order
<b>Exhaust Silencers / Flow Regulators</b>	extra to order
<b>Hazardous Areas</b>	certified solenoids are available as extras to order
<b>Environmental Protection</b>	to IP65 as standard
<b>Minimum Air Supply</b>	2 bar

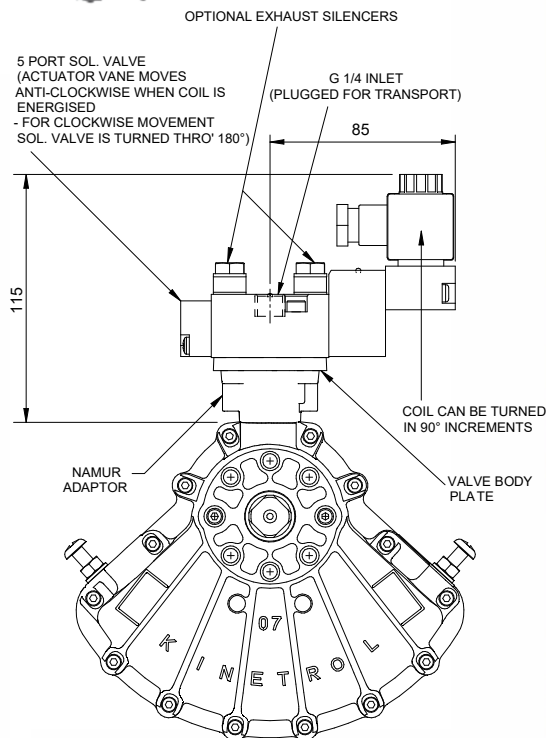

Single solenoid, 3 or 5 port, interchangeable for double acting or spring return, NAMUR interface. Most brands of NAMUR interface solenoid valve can be supplied to special order.

